

Cenník

Názov	Frakcia	Obsah	cena bez DPH	cena s DPH
-------	---------	-------	--------------	------------

Kamenný koberec Štandard

Venus	4-8mm	Kamenivo+pojivo	11,66 €	13,99 €
Mercury	4-8mm	Kamenivo+pojivo	11,66 €	13,99 €
Mars	2-5mm	Kamenivo+pojivo	11,66 €	13,99 €
Venus S-M	4-6mm	Kamenivo+pojivo	11,66 €	13,99 €
Venus svetlá	4-8mm	Kamenivo+pojivo	11,66 €	13,99 €
Ganymedes	2-8mm	Kamenivo+pojivo	11,66 €	13,99 €
Phobos	2-8mm	Kamenivo+pojivo	11,66 €	13,99 €

Kamenný koberec Exclusive

Biela	2-4mm	Kamenivo+pojivo	19,17 €	23,00 €
Žltá	2-4mm	Kamenivo+pojivo	20,00 €	24,00 €
Korálová	2-4mm	Kamenivo+pojivo	20,00 €	24,00 €
Tehlová	2-4mm	Kamenivo+pojivo	20,00 €	24,00 €
Kávová	2-4mm	Kamenivo+pojivo	20,83	25,00 €
Zelená	2-4mm	Kamenivo+pojivo	20,83	25,00 €
Čierna	2-4mm	Kamenivo+pojivo	20,00 €	24,00 €
Šedočierna	2-4mm	Kamenivo+pojivo	21,67 €	26,00 €
Sorbet	2-4mm	Kamenivo+pojivo	21,67 €	26,00 €
Japanese	2-4mm	Kamenivo+pojivo	21,67 €	26,00 €
Šedá	2-4mm	Kamenivo+pojivo	20,83	25,00 €
Slonova kosť	2-4mm	Kamenivo+pojivo	19,17 €	23,00 €
Japanese II.	2-4mm	Kamenivo+pojivo	21,67 €	26,00 €
Londýnska šedá	2-4mm	Kamenivo+pojivo	20,83	25,00 €

Kráľovská hnedá	2-4mm	Kamenivo+pojivo	21,67 €	26,00 €
Ružová	2-4mm	Kamenivo+pojivo	21,67 €	26,00 €
Svetlošedá	2-4mm	Kamenivo+pojivo	21,67 €	26,00 €
všetky mixy	2-4mm	Kamenivo+pojivo	21,67 €	26,00 €

Kamenný koberec Exclusive XL

Biela	4-7mm	Kamenivo+pojivo	19,17 €	23,00 €
Žltá	4-7mm	Kamenivo+pojivo	20,00 €	24,00 €
Korálová	4-7mm	Kamenivo+pojivo	20,00 €	24,00 €
Tehlová	4-7mm	Kamenivo+pojivo	20,00 €	24,00 €
Kávová	4-7mm	Kamenivo+pojivo	20,83	25,00 €
Zelená	4-7mm	Kamenivo+pojivo	20,83	25,00 €
Čierna	4-7mm	Kamenivo+pojivo	20,00 €	24,00 €
Šedočierna	4-7mm	Kamenivo+pojivo	21,67 €	26,00 €
Sorbet	4-7mm	Kamenivo+pojivo	21,67 €	26,00 €
Japanese	4-7mm	Kamenivo+pojivo	21,67 €	26,00 €
Šedá	4-7mm	Kamenivo+pojivo	20,83	25,00 €
Slonova kosť	4-7mm	Kamenivo+pojivo	19,17 €	23,00 €
Japanese II.	4-7mm	Kamenivo+pojivo	21,67 €	26,00 €
Londýnska šedá	4-7mm	Kamenivo+pojivo	20,83	25,00 €
Kráľovská hnedá	4-7mm	Kamenivo+pojivo	21,67 €	26,00 €
Ružová	4-7mm	Kamenivo+pojivo	21,67 €	26,00 €
Svetlošedá	4-7mm	Kamenivo+pojivo	21,67 €	26,00 €
všetky mixy	4-7mm	Kamenivo+pojivo	21,67 €	26,00 €

Chémia + príslušenstvo

bal.m2	Obsah	cena bez DPH	cena s DPH
1	Dvojbložkové epox.spojivo	8,33 €	10,00 €

cca 5	Epoxidová penetrácia	8,33 €	10,00 €
1	Seal-vodeodolný náter	10,00 €	12,00 €
cca 3	Regeneračný náter	8,33 €	10,00 €
5	Ochranný náter pre exter.pre S01	10,42 €	12,50 €
2	Trojzložkove epox.lepidlo na lepenie profilov	10,83 €	13,00 €

Ohybateľný obklad

Štiepaný kameň, Mini štiepaný kameň, Skala, Tehla, Stará tehla

cena bez DPH	cena s DPH
11,25 €	13,50 €

objednávky na balenie/v balení 4m2

Flexibilné lepidlá

mrazuvzdorné lepidlo: Bliely flexi kleber 25kg/bal.

Šedý flexi Kleber 25kg/bal.

cena bez DPH	cena s DPH
12,42 €	14,90 €
7,08 €	8,49 €

Výdatnosť 1 balenie

Výdatnosť (m2)	Odporúčaná skupina	Hrúbka vrstvy	Skupiny podľa frakcie:	
1m2	1,2	14mm	Frakcia kameniva	Skupina
1,17m2	1,2	12mm	2-5mm,2-4mm,4-6mm	1
1,40m2	1	10mm	2,8mm,4-7mm,4-8mm	2
1,75m2	1	8mm		

Cenník

Ikon s fázou

	DxŠxV (cm)
normál	20 x 16,5 x 6
	20 x 16,5 x 8
	20 x 16,5 x 10
polovičný	10 x 16,5 x 6
	10 x 16,5 x 8
krajový	20 x 16,5 x 6
	20 x 16,5 x 8



Hmotnosť palety	Spotreba m ² alebo bm	Množstvo na paletu	Cena za k € bez DPH
-----------------	----------------------------------	--------------------	---------------------

1425 kg	36,36 ks	10,89 m ²	7,84
1548 kg	36,36 ks	8,91 m ²	9,28
1474 kg	36,36 ks	6,93 m ²	10,72
1378 kg	73,47 ks	792 ks	7,84
1509 kg	73,47 ks	648 ks	9,28
1560 kg	33,33 ks	396 ks	7,84
1497 kg	33,33 ks	288 ks	9,28

Ikon bez fázy

	DxŠxV (cm)
normál	20 x 16,5 x 6
	20 x 16,5 x 8
polovičný	10 x 16,5 x 6
	10 x 16,5 x 8



1425 kg	36,36 ks	10,89 m ²	7,84
1450 kg	36,36 ks	8,19 m ²	9,28
1378 kg	73,47 ks	792 ks	7,84
1509 kg	73,47 ks	648 ks	9,28

Esko s fázou

	DxŠxV (cm)
normál	22,5 x 11,25 x 6
	22,5 x 11,25 x 8
polovičné	11,25 x 11,25 x 6
	11,25 x 11,25 x 8
krajové	22,5 x 11,25 x 6
	22,5 x 11,25 x 8



1412 kg	40,40 ks	10,89 m ²	7,84
1540 kg	40,40 ks	8,91 m ²	9,28
1408 kg	80,80 ks	286 ks	7,84
1516 kg	80,80 ks	234 ks	9,28
1408 kg	40,40 ks	297 ks	7,84
1516 kg	40,40 ks	243 ks	9,28

Polovičné a krajové sú ukladané spolu na paletu (v jednom rade je 26ks polovičných)

Esko bez fázy

DxŠxV (cm)

normál

22,5 x 11,25 x 6
22,5 x 11,25 x 8



1412 kg	40,40 ks	10,89 m ²	7,84
1540 kg	40,40 ks	8,91 m ²	9,28

Brik EK s fázou

DxŠxV (cm)

20 x 20 x 6
výsek 5 x 5



1440 kg	102,06 ks	11,2 m ²	7,84
---------	-----------	---------------------	------

Brik s fázou

Hmotnosť palety	Spotreba m ² alebo bm	Množstvo na paletu	Cena za k € bez DPH
-----------------	----------------------------------	--------------------	---------------------

	DxŠxV (cm)
malý štvorec	10 x 10 x 6
obdĺžnik	20 x 10 x 6
veľký štvorec	20 x 20 x 6
malý štvorec	10 x 10 x 8
obdĺžnik	20 x 10 x 8
veľký štvorec	20 x 20 x 8
veľký obdĺžnik	30 x 20 x 8

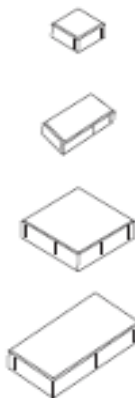

1148 kg	102,06 ks	9,70 m ²	7,84
1394 kg	50,94 ks	10,60 m ²	7,84
1521 kg	25,21 ks	11,90 m ²	7,84
1503 kg	102,06 ks	8,48 m ²	9,28
1503 kg	50,94 ks	8,48 m ²	9,28
1641 kg	25,21 ks	9,52 m ²	9,28
1641 kg	16,66 ks	9,52 m ²	9,28

Brik bez fázy

	DxŠxV (cm)
malý štvorec	10 x 10 x 6
obdĺžnik	20 x 10 x 6
veľký štvorec	20 x 20 x 6

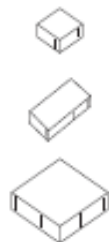

1148 kg	102,06 ks	9,70 m ²	7,84
1394 kg	50,94 ks	10,60 m ²	7,84
1521 kg	25,21 ks	11,90 m ²	7,84

Pre nevidiacich s fázou

DxŠxV (cm)



s varovnou funkciou
nopková
s vodiacou funkciou
drážková

<u>20 x 10 x 6</u>
<u>20 x 20 x 6</u>



1394 kg	50,94 ks	10,60 m ²	12,80
1521 kg	25,21 ks	11,90 m ²	12,80

Pazl s fázou

<u>DxŠxV (cm)</u>
<u>cca 33 x 34 x 8</u>

1200 kg	15,18 ks	7,11 m ²	19,20
---------	----------	---------------------	-------

Reliéfová dlažba hrúbky 8cm, jedna vrstva obsahuje 12 prvkov v 6 variáciách, po 2 kusoch vzájomne kombinovateľných, bez ukončovacích prvkov. Dodáva sa v ucelených radoch.

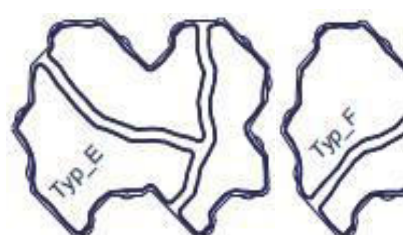
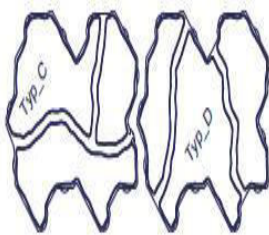
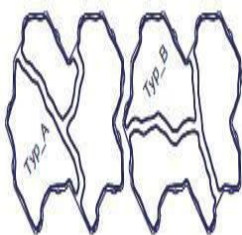

Herba zatrávňovacia s fázou

	<u>DxŠxV (cm)</u>
normál	<u>45 x 45 x 8</u>
polovičná	<u>45 x 22,5 x 8</u>



Hmotnosť palety	Spotreba m ² alebo bm	Množstvo na paletu	Cena za k € bez DPH
-----------------	----------------------------------	--------------------	---------------------

980 kg	4,94 ks	10,13 m ²	9,28
--------	---------	----------------------	------

980 kg	9,88 ks	10,13 m ²	9,28
--------	---------	----------------------	------

Polovičné a normál sú ukladané spolu na paletu (v jednom rade sú 4 ks normál a 2ks

Obrubník parkový

	<u>DxŠxV (cm)</u>
normál	<u>100 x 5 x 20</u>
polovičný	<u>50 x 5 x 20</u>

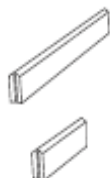

1122 kg	1 ks	51 ks	2,13
---------	------	-------	------

1122 kg	1 ks	102 ks	1,12
---------	------	--------	------



Obrubník chodníkový

	<u>DxŠxV (cm)</u>
skosenie 1,5/1,5cm	<u>100 x 10 x 20</u>



1230 kg	1 ks	27 ks	2,80
---------	------	-------	------

Obrubník cestný

	DxŠxV (cm)						
so skosením 15/3cm	100 x 15 x 25		1566 kg	1 ks	18 ks	4,25	
so skosením 15/3cm tr	33 x 15 x 25		1566 kg	1 ks	54 ks	2,20	
bez skosenia	100 x 15 x 25		1620 kg	1 ks	18 ks	4,25	

Prídlažba

DxŠxV (cm)							
50 x 25 x 8		1497 kg	8 ks	64 ks	1,35		

Debniace tvárnice

DxŠxV (cm)							
50 x 15 x 25		1140 kg	8 ks	60 ks	0,95		
50 x 20 x 25		1200 kg	8 ks	50 ks	1,05		
50 x 30 x 25		870 kg	8 ks	30 ks	1,27		
50 x 40 x 25		660 kg	8 ks	20 ks	1,59		

Za farebné vyhotovenie zámkovej dlažby sa účtuje príplatok 1,00€ bez DPH za m² (piesková, hnedá, čer
Za farebné vyhotovenie parkového obrubníka sa účtuje príplatok 0,45€ bez DPH za kus (piesková, hned
Uvedené ceny sú bez prepravy pri parite FCA Senec.

TIETO VŠEOBECNÉ OBCHODNÉ PODMIENKY UPRAVUJÚ VZŤAHY MEDZI SPOLOČN

CENA: Predajná cena je stanovená v katalógu výrobcu. V cene tovaru sú zahrnuté náklady

DODACIE A PLATOBNÉ PODMIENKY: Štandardná dodacia podmienka je FCA Senec (t.j
Platobné podmienky budú dohodnuté v potvrdení objednávky, pričom štandardne je požadc

ZÁRUKA: Predávajúci poskytuje záruku za kvalitu tovaru v rozsahu, ktorý je určený príslušr

REKLAMÁCIE: Kupujúci je povinný pri odbere tovaru skontrolovať hlavne neporušenosť ba

PALETOVÉ HOSPODÁRSTVO: Za palety (100x120 cm) sa pri odbere účtuje záloha 8,- El

 - správne uloženie zámkovej dlažby- 3mm medzerník + 2mm vôla

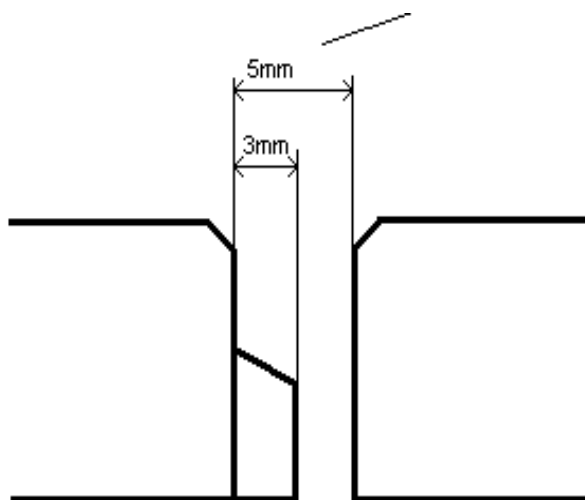

- vyhody dlazby s 3mm medzernikom
- lepšia presiakavosť vody
- vyšia pružnosť a odolnosť plochy
- úspora materialu

(Naše výrobky vyrábame na najmodernejšej nemeckej technológii od firmy REKERS.)

cs alebo m²
€ s DPH

9,41
11,14
12,86
9,41
11,14
9,41
11,14

9,41
11,14

9,41
11,14

9,41
11,14

9,41
11,14

9,41
11,14

a 27ks krajových)

9,41
11,14

9,41

cs alebo m ²
€ s DPH

9,41

9,41

9,41

11,14

11,14

11,14

11,14

9,41

9,41

9,41

15,36

15,36

23,04



cs alebo m²

€ s DPH

11,14

11,14

polovičných)

2,56

1,34

3,36

5,10

2,64

5,10

1,62

1,14

1,26

1,52

1,91

vená, antracitová).
lá, červená, antracitová).

OSŤOU

spojené s

i. naložené
ovaná

rou STN

lenia a

JR bez